



规格承认书

SPEC FOR APPROVAL

客户名称 Customer	
客户料号 Customer P/N	
我司型号 Model	SK-IR5RT-1290-D
产品名称 Product Name	直插红外发射管

客户确认(Customer Signatures)		
编制(Edit)	审核(Check)	核准(Approval)

产品外形尺寸 Package outline dimensions

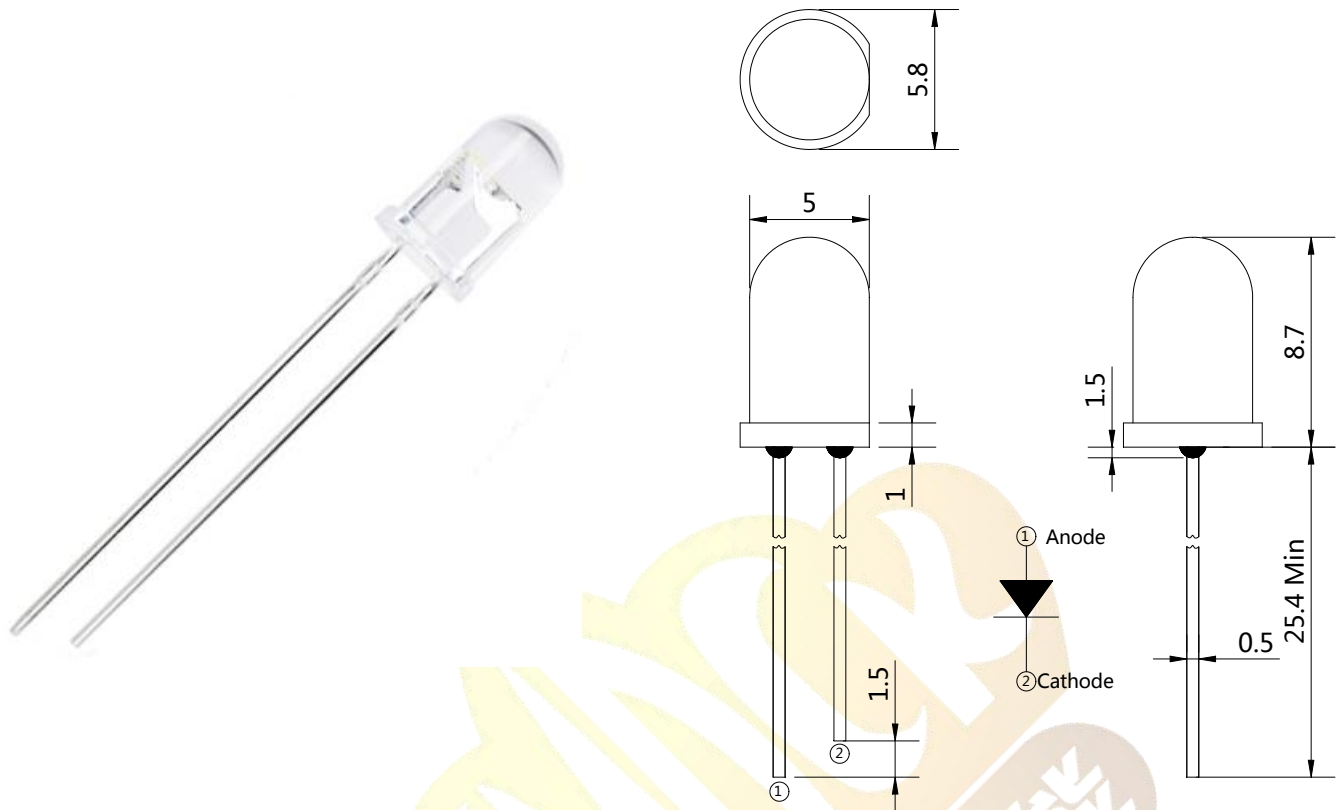

特性 Features

- 峰值波长 940nm Peak wavelength $\lambda_p=940\text{nm}$
- 高可靠性 High reliability
- 低功耗 Low Power Consumption
- 散热快 Fast heat dissipation
- 发光角度均匀 Uniform luminous angle
- 符合 RoHS compliant RoHS
- 可回流焊接 Soldering methods: Reflow soldering

应用 Applications

- 人脸识别 Face recognition
- 监控系统 Surveillance System
- 红外相机 Infrared Illumination for cameras
- 机器视觉系统 Machine visual systems
- 智能家居 Smart home
- 虹膜识别 Iris Recognition
- 红外遥控对管 Infrared remote control tube

额定参数 Absolute Maximum Ratings (Ta=25°C)

电气特性 Electrical characteristics	符号 Symbol	额定值 Rated Value	单位 Unit
最大持续工作电流 Max continuous working current	IF	60	mA
最大脉冲工作电流* Max pulse current	IFP	1000	mA
反向击穿电压 Reverse breakdown voltage	VR	5	V
最大功耗 Power dissipation	Pd	75	mW
工作温度 Operating Temperature	Topr	-30--+85	°C
储存温度 Storage Temperature	Tstg	-40--+100	°C

Note : * Pulse width \leq 100 μ s, Duty \leq 1%

光电特性 Elector-Optical Characteristics (Ta=25°C)

参数 Parameter	符号 Symbol	测试条件 Test Condition	最小 Min	典型 Type	最大 Max	单位 Unit
峰值波长 Peak wavelength	λ_p	IF=60mA	--	940	--	nm
辐射光强 Radiation intensity	Po	IF=60mA	6	8	--	mw/sr
工作电压 Forward Voltage	VF	IF=60mA	1.35	1.4	1.6	V
反向电流 Reverse current	IR	VR=5V	--	--	10	μ A
发射角度 Emission Angle	2 $\theta_{1/2}$	IF=60mA	--	90	--	Deg.

光电特性曲线 Typical elector-optical characteristics curves

光谱分布特性曲线
Relative Spectral Distribution

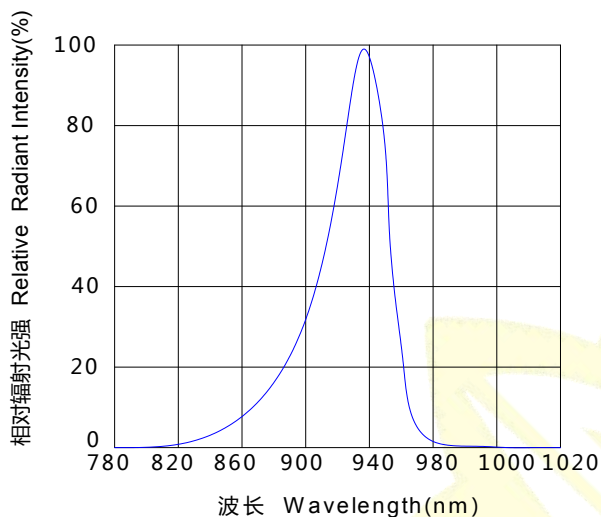

温度VS电流曲线
Forward Current Derating Curve

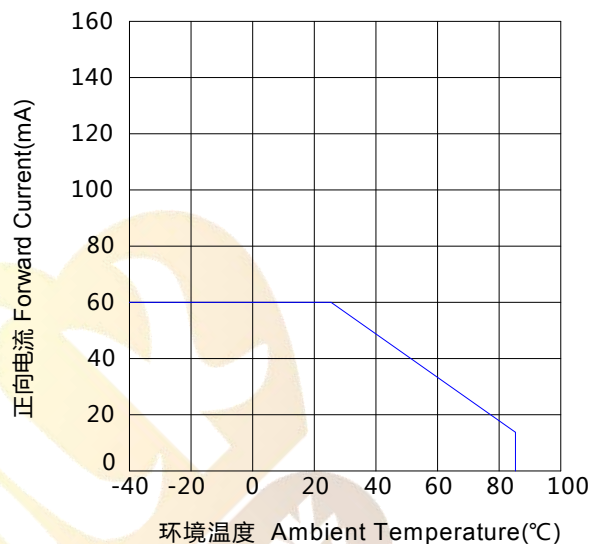

电流vs电压曲线图
Current & Voltage Curve

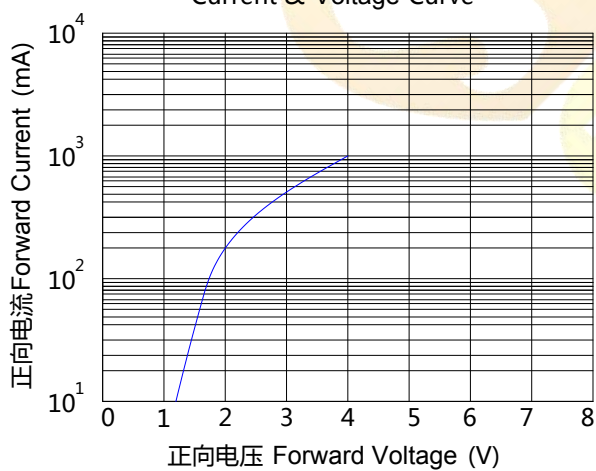

辐射光强分布特性曲线
Radiant Intensity Spatial Distribution

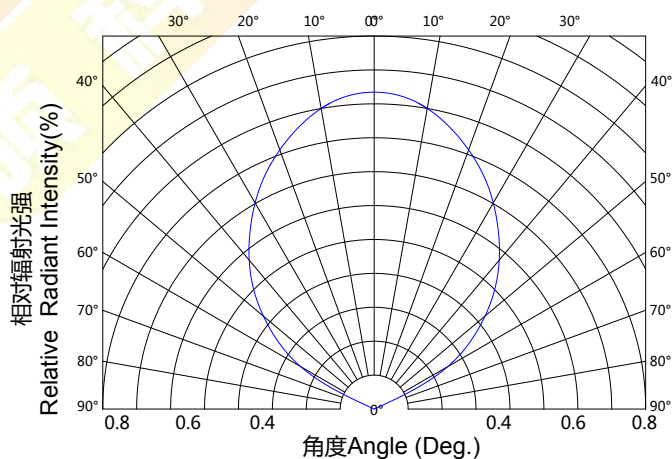

推荐焊接条件 Recommended Soldering Conditions

焊接模式 Mode		固定形式 Fixed form
手工焊接 Manually Soldering	烙铁温度 Soldering Iron Temperature	最高温度 300°C(功率最大 30 瓦) 300°C Max(30w Max)
	焊接时间 Soldering Time	时间不超过 3 秒 3 sec Max
	焊接位置 Soldering Position	大于 3mm (从焊点到胶体) 3mm Min.(Form soldering joint to colloid)
波峰焊接 Wave Soldering	预热 Preheat	最高温度 100°C 不超过 60 秒 100°C Max.60 sec.Max
	温度 Temperature	最高 260°C 260°C Max.
	焊接时间 Soldering Time	不超过 5 秒 5 sec Max
锡炉焊接 Solder pot Soldering	预热 Preheat	最高温度 100°C 不超过 60 秒 100°C Max.60 sec.Max
	浸焊温度 Preheat Temperature	最高 260°C 260°C Max.
	浸焊时间 Soldering Time	不超过 5 秒 5 sec Max
	焊接位置 Soldering Position	大于 2mm (从焊点到胶体) 2mm Min.(From soldering joint to colloid)

■ 储存 Storage

- 在温度不高于 30°C，湿度不高于 60%RH 的条件下，产品保存期限为 6 个月。将产品保存在密封的容器中并附带干燥剂可以在一定程度上延续产品的储存日期。不良的储存条件会导致产品引脚的腐蚀或产品性能的改变。

Under the storage conditions of 30°C or less and humidity less than 60%RH, the storage period of LED is 6months. Store the products in sealed container with moisture absorbent material could prolong the storage time to a certain extent. Bad storage conditions may cause the LED pin corrode or LED characteristics be changed. It is recommended that the LEDs be used as soon as possible.

- 开封后,产品必须 24 小时内使用完(建议工作环境温度不高于 30°C,湿度不高于 60%),如未使用完,余料须存放在温度不高于 30°C,湿度不高于 10%的环境中。

After opening package, the product should be soldered within 24 hours. If not, please store at 30°C or less and

humidity less than 10%RH. It is recommended that the product be operated at the workshop condition of 30°C or less and humidity less than 60%RH.

- 对于尚未焊接的 LED,如果吸湿剂或包装失效,或者产品没有符合以上有效存储条件,烘烤可以起到一定的性能恢复效果. 烘烤条件:65±5°C,持续时间 24H。

For the LED doesn't solder ,if the moisture absorbent material lose efficacy or the storage condition doesn't conform to the above description,baking can help performance recovery in some extent.Backing condition : 65±5°C for 24 hours.

■ 静电 Static electricity

- 静电和电涌会导致产品特性发生改变,例如正向电压降低等,如果情况严重甚至会损毁产品,所以在使用时必须采取有效的防静电措施。所有相关的设备和机器都应该正确的接地,同时必须采取其他防静电和电涌的措施。使用防静电手环,防静电垫子,防静电工作服,工作鞋,手套,防静电容器,都是有效的防止静电和电涌的措施。

Static and electric surge would change the features of LED,such as decreasing of forward voltage.Even damages may occur in serious conditions.Please make sure adopt effective anti-static measures. All the relative devices and machinery must be properly grounded. At the same time, it is recommended to use anti-static wrist bands,anti-electrostatic gloves, anti-electrostatic containers and so on to prevent static and electric surge.

可靠性试验 Reliability Test

测试项目 Test Parameter	测试条件 Test Condition	时间 Time	样品数 Quantity	Ac/Re
耐焊接热 Resistance to Solder Heat	260°C±5°C	10 sec	22PCS	0/1
冷热循环 temperature cycle	+100°C(15min) 5min -10°C(15min)	50 cycles	22PCS	0/1
冷热冲击 Thermal Shock	+105°C(30min) 5min -45°C(30min)	50 cycles	22PCS	0/1
高温贮存 High Temperature storage	+100°C	1000H	22PCS	0/1
低温贮存 Low Temperature storage	-40°C	1000H	22PCS	0/1
寿命测试 Life Test	V _{CE} =5V	1000H	22PCS	0/1
高温高湿 High Temperature and High Humidity Test	85°C&85%R.H	168H	22PCS	0/1

包装规格 Packing Specification

最小包装 : 1000PCS/包

Minimum package: 1, 000 PCS/ package