

透镜图片 (Lens Picture) :

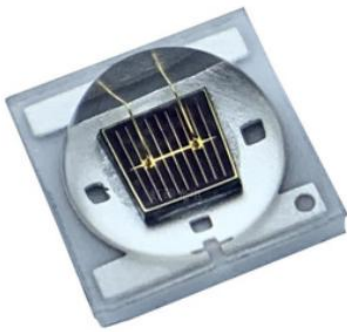

搭配 LED 图片 (Matair with LED pictures) :



透镜信息 Lens for information	符号 Symbol	范围 Scope	单位 Unit
透镜材料 Lens-based material	PC	--	--
支架材料 Support material	PC	--	--
操作温度 Service temperature	Topr	-30--+85	°C
保存温度 Save the temperature	Topr	-30--+85	°C
产品重量 Product weight	M	0.6	g
产品高度 Product height	H	7	mm
产品直径 Product diameter	D	10.8	mm
出光角度 Light-out angle	2θ _{1/2}	57-62	°

应用 Applications

- 人脸识别 Face recognition
- 监控系统 Surveillance System
- 红外相机 Infrared Illumination for cameras
- 机器视觉系统 Machine visual systems
- 智能家居 Smart home
- 补光照明 Light lighting

特性 Features

- 专为 3535 红外 LED 设计
Designed specifically for the 3535 infrared LED
- 透过率 93% Transmission rate of 93%
- 发光角度均匀 Uniform luminous angle
- 符合 RoHS compliant RoHS
- 搭配 6mm 镜头 With a 6mm lens

以下测试光源为 3535 封装 LED,测量光束角为 58-62°

透镜外形尺寸 Len profile dimensions

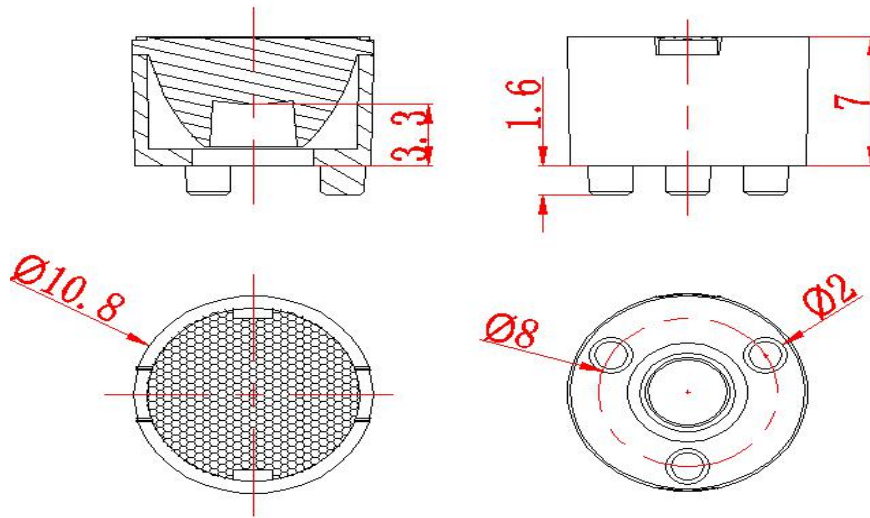

配光曲线-直角坐标 Light distribution curve-right-angle coordinates

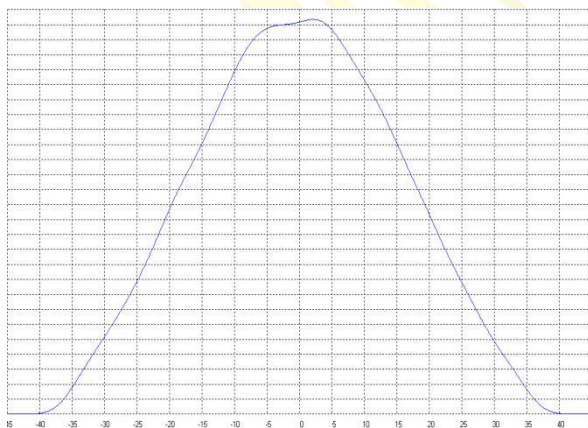

配光曲线-极坐标 Light distribution curve-polar coordinates

